

### Application

Ideal for use where Lead-Free\* valves are required. Designed for installation on potable water lines to protect against backsiphonage of contaminated water into the potable water supply. Assembly shall provide protection where a potential health hazard exists.



Model 35XLCH (1/2") Model 35XLVCH (1/4") Model 35XL (3/4" - 2")

### Standards Compliance

- ASSE® Listed 1001
- CSA® Certified
- IAPMO® Listed
- IAPMO® Listed - California Lead Plumbing Law\*  
\*(0.25% max. weighted average lead content)



### Materials

Main valve body	Lead-Free Cast Brass (1/4" - 1/2") Cast Bronze ASTM B 584 (3/4" - 2")
Elastomers	Silicone (FDA approved) Buna Nitrile (FDA approved)
Polymers	ULTEM™, NSF Listed (1/4" - 1/2") Polypropylene (3/4" - 2")

### Options

- (Suffixes can be combined)
- CH - with rough chrome plate finish (1/2" only)
  - VCH - with vertical inlet and outlet with rough chrome finish (1/4" only)

### Features

Sizes: 1/4, 1/2", 3/4", 1", 1 1/4", 1 1/2", 2"

### Accessories

- SXL - Lead-Free Bronze Wye Strainer

Maximum working water pressure 125 PSI  
Maximum working water temperature 180°F

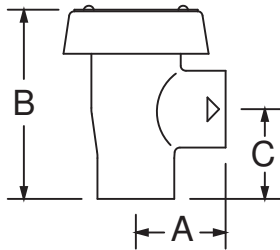

35XL (1/2")

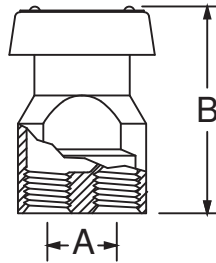

35XLVCH (1/4")

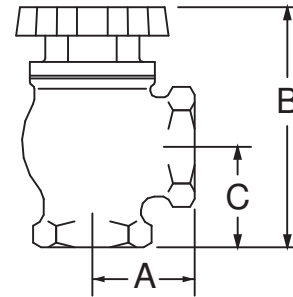

35XL (3/4" - 2")

### Dimensions (do not include pkg.)

MODEL SIZE		DIMENSIONS (approximate)						WEIGHT	
		A		B		C			
in.	mm	in.	mm	in.	mm	in.	mm	lbs.	kg
1/4 VCH	8	3/4	19	2 3/8	60	N/A	N/A	1	0.5
1/2	15	1 5/16	33	2 1/2	64	1 1/4	32	2	0.9
3/4	20	1 1/2	38	2 15/16	75	1 1/2	38	2	0.9
1	25	1 5/8	41	2 5/16	51	1 1/2	38	2	0.9
1 1/4	32	2	51	4 1/2	114	2	51	3	1.4
1 1/2	40	2 1/4	57	4 7/8	124	2 1/16	52	4	1.8
2	50	2 3/4	70	5 9/16	141	2 1/2	64	6	2.7

**MODEL 35XL 1/4" & 1/2"(STANDARD & METRIC)**

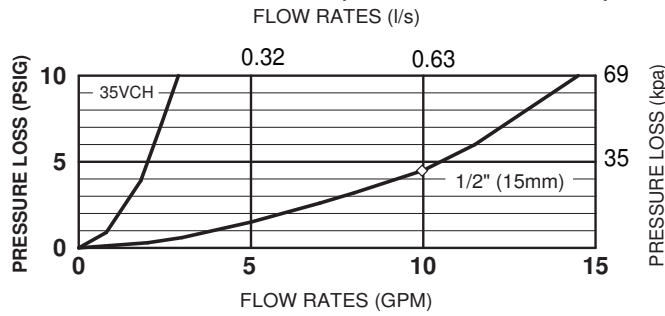

**MODEL 35XL 3/4", 1", 1 1/4" 1 1/2" & 2"(STANDARD & METRIC)**

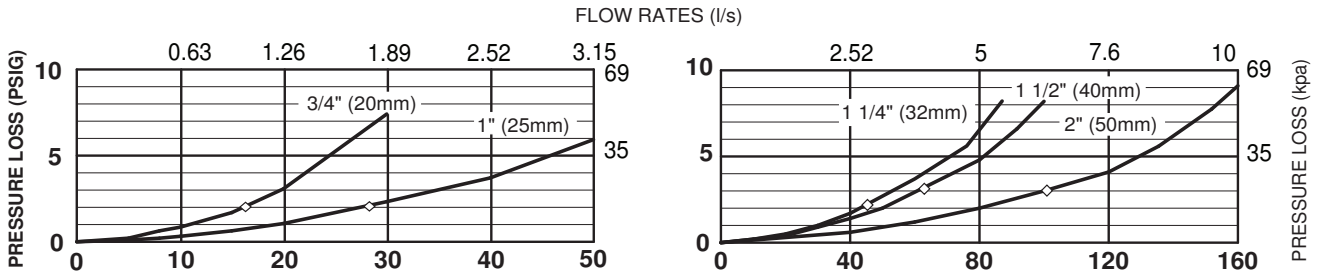

**Typical Installation**

Local codes shall govern installation requirements. To be installed in accordance with the manufacturer’s instructions and the latest edition of the Uniform Plumbing Code. Unless otherwise specified, the assembly shall be mounted at a minimum of 6" (150mm) above the highest point of discharge with sufficient side clearance for maintenance. Because the Model 35 is not to be used under continuous pressure never place a shut-off or check valve downstream of the device. The installation shall be made so that no part of the unit can be submerged.

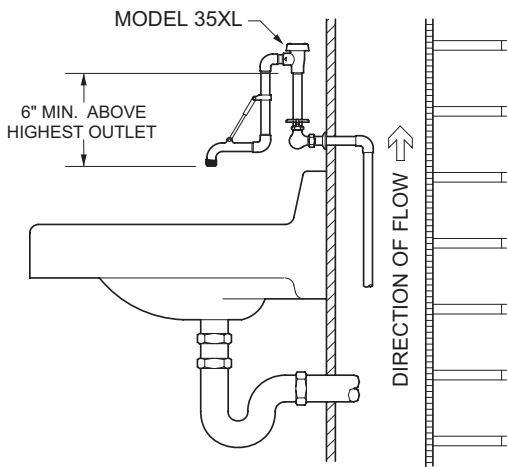

**MODEL 35XL INSTALLATION**

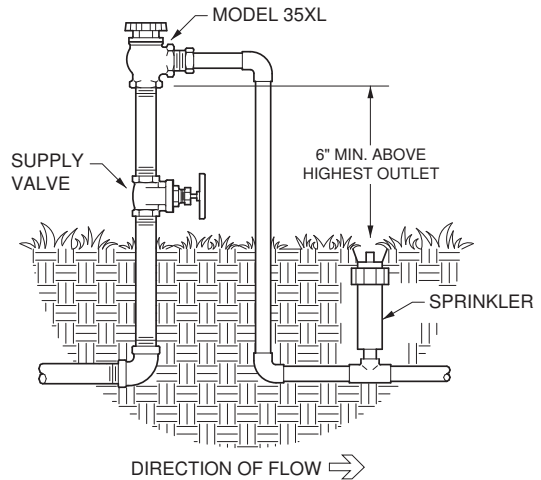

**MODEL 35XL INSTALLATION**

**Specifications**

The Atmospheric Vacuum Breaker shall be ANSI 3rd party certified to comply with states' lead plumbing law 0.25% maximum weighted average lead content requirement, ASSE® Listed 1001. The main body shall be low lead brass (1/4"-2"). All internal polymers shall be NSF® Listed ULTEM™ or Polypropylene and the seat disc elastomers shall be Silicone. The device shall be accessible for maintenance without removing the device from the service line. The installation shall not be in a concealed or inaccessible location, or where the venting of water from the device, during normal functioning, may be deemed objectionable. The Atmospheric Vacuum Breaker shall be a WILKINS Model 35XL or Model 35XLVCH.